

Affinity Lunch Minutes

Speaker plot

DESIGNER:
Casey Deiter
casey.deiter@ucf.edu

SCALE:
3/16" = 1'-0"

DRAWN:
04/27/22

PLATE

1

OF 9

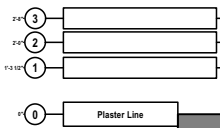

1: Main Left
QSC ILA Array
1x QSC WL 118-SW
4x QSC WL 2082i
0°H x 0° V
12' flown via motors

2: Main Right
QSC ILA Array
1x QSC WL 118-SW
4x QSC WL 2082i
0°H x 0° V
12' flown via motors

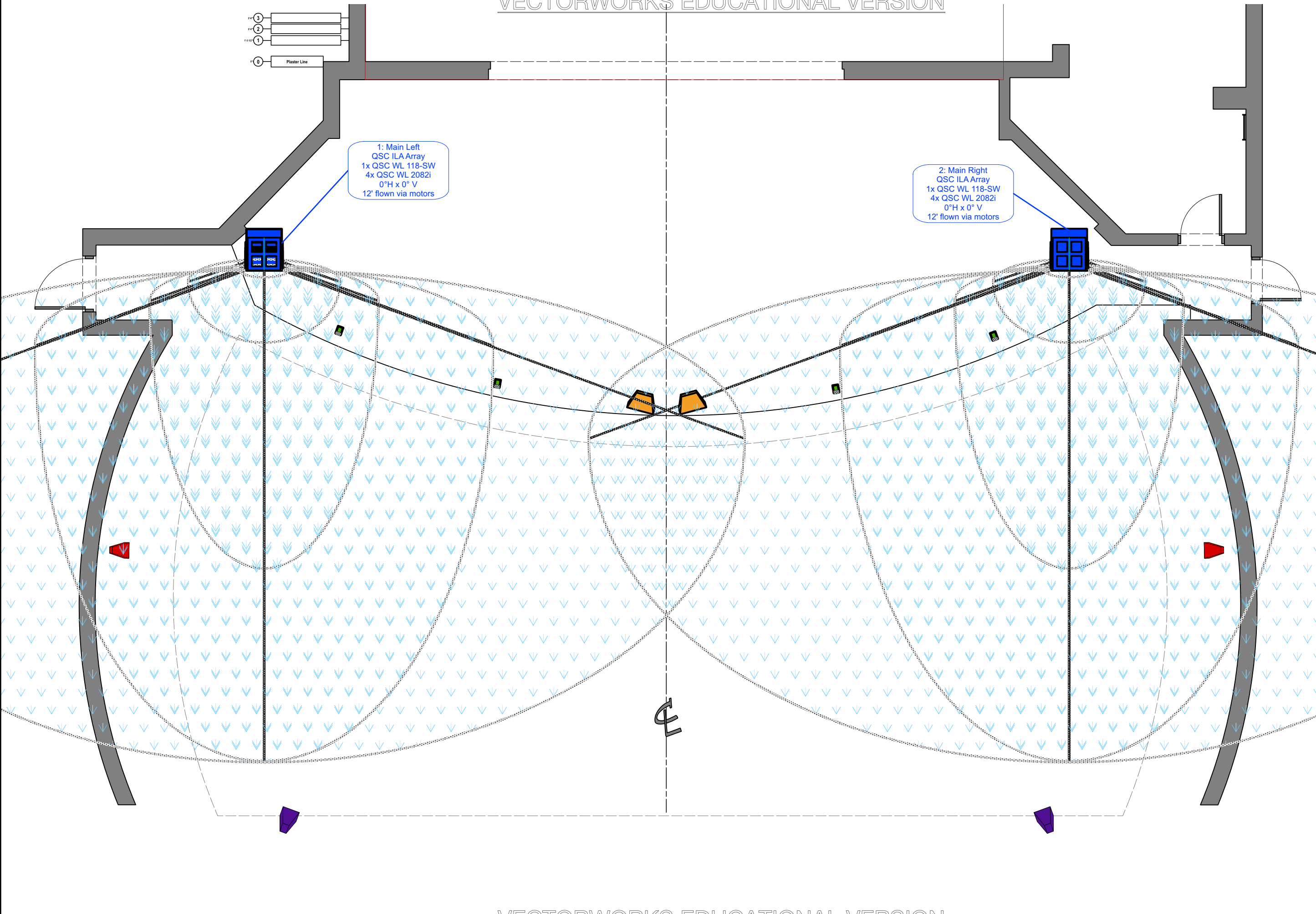

Affinity Lunch Minutes

Main LR Coverage

DESIGNER:
Casey Deiter
casey.deiter@ucf.edu

SCALE:
3/16" = 1'-0"

DRAWN:
04/27/22

PLATE

2

OF 9

Affinity Lunch Minutes

Center LR Coverage

DESIGNER:
Casey Deiter
casey.deiter@ucf.edu

SCALE:
3/16" = 1'-0"

DRAWN:
04/27/22

PLATE

3

OF 9

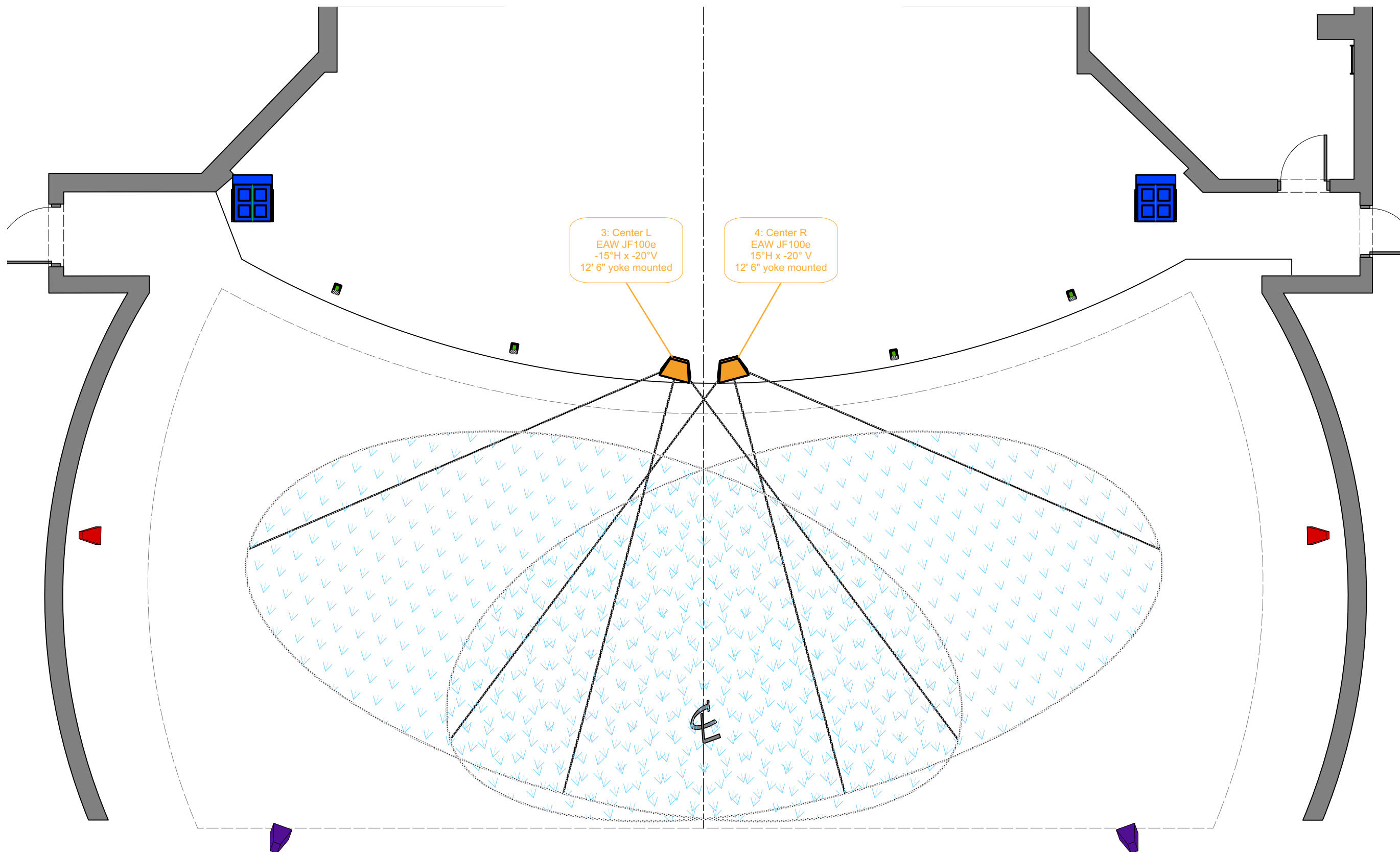

Affinity Lunch Minutes

Side and Rear Coverage

DESIGNER:
Casey Deiter
casey.deiter@ucf.edu

SCALE:
3/16" = 1'-0"

DRAWN:
04/27/22

PLATE

4

OF 9

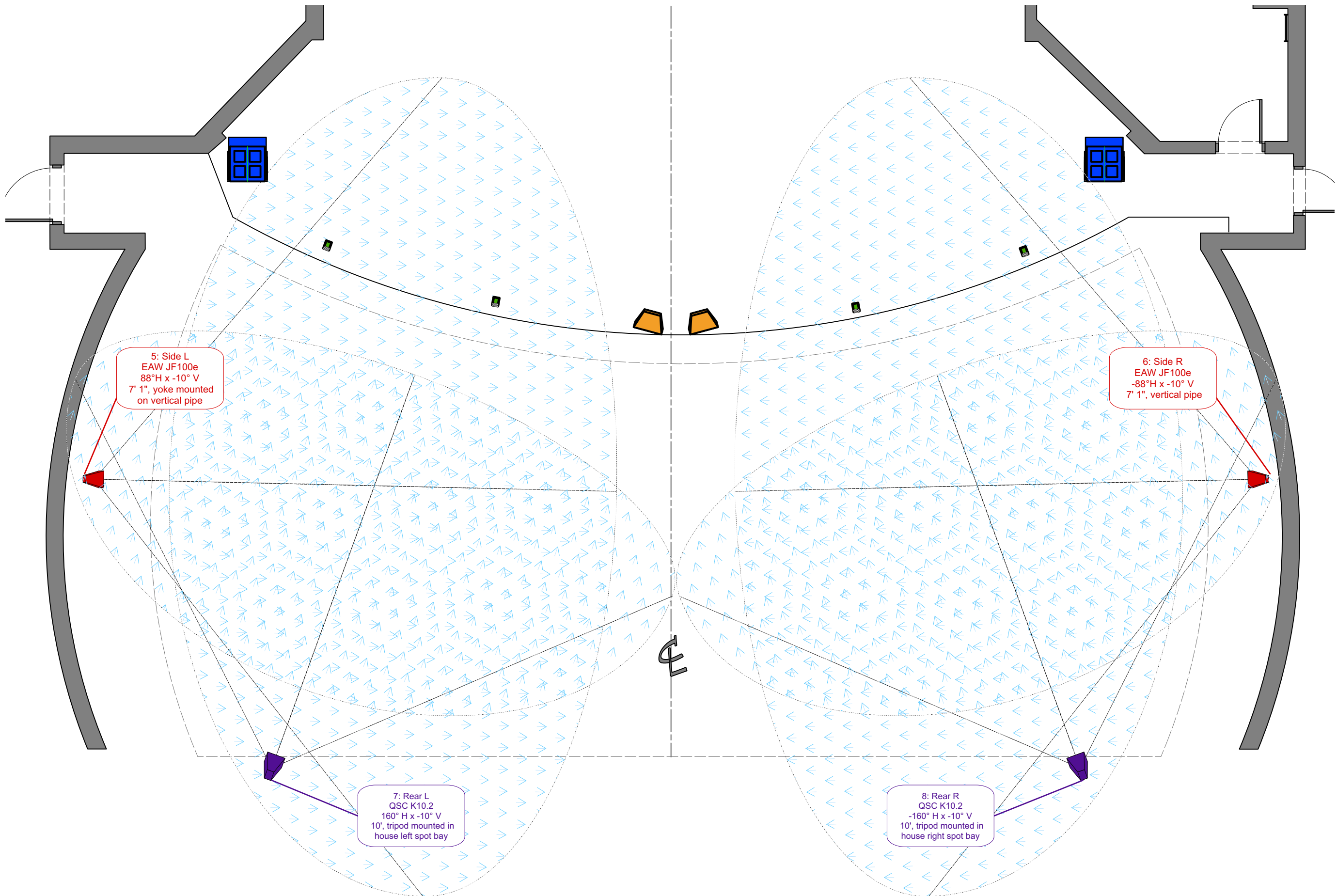

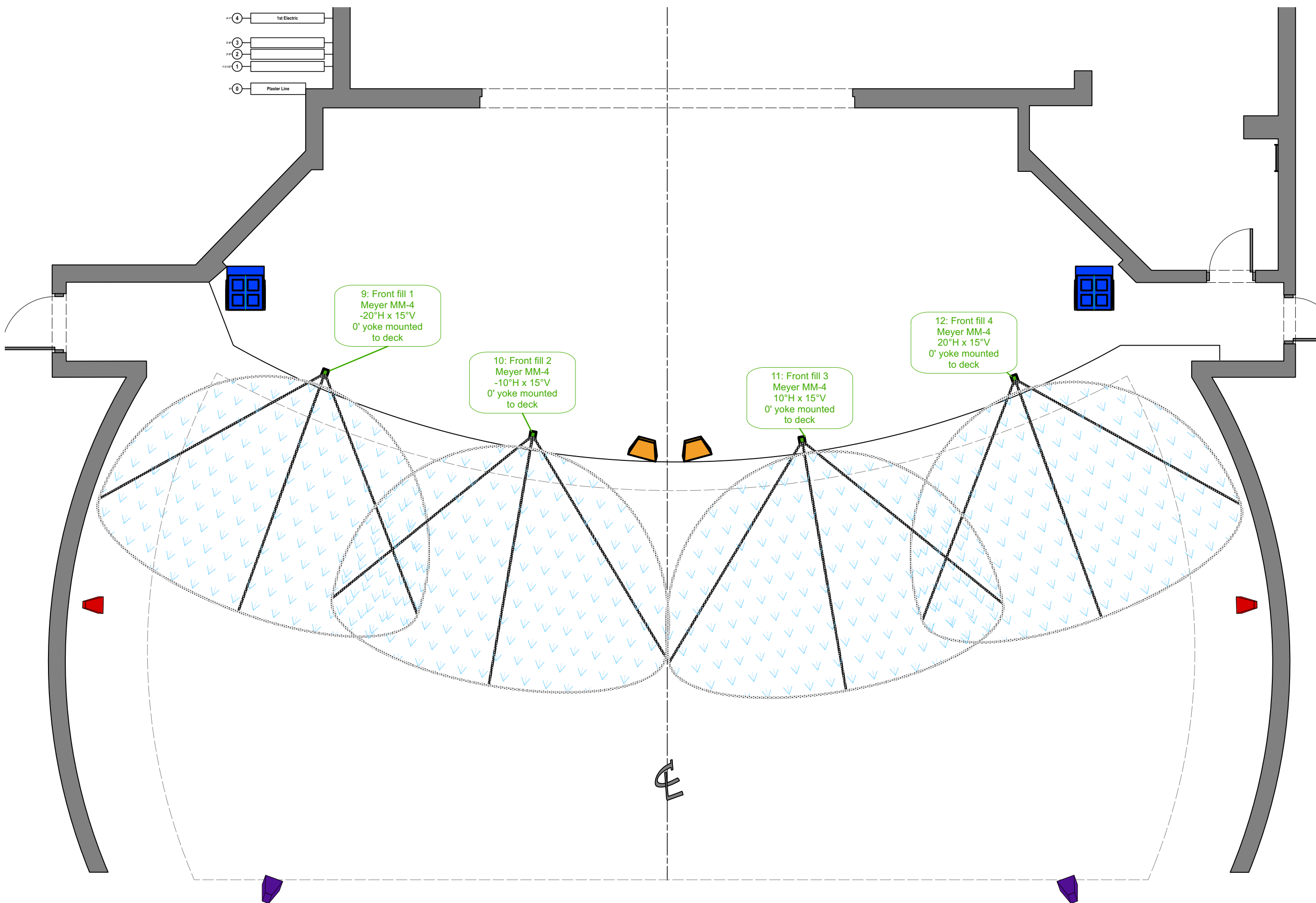
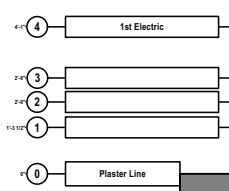

Affinity Lunch Minutes

Front Fill Coverage

DESIGNER:
Casey Deiter
casey.deiter@ucf.edu

SCALE:
3/16" = 1'-0"

DRAWN:
04/27/22

PLATE

5

OF 9

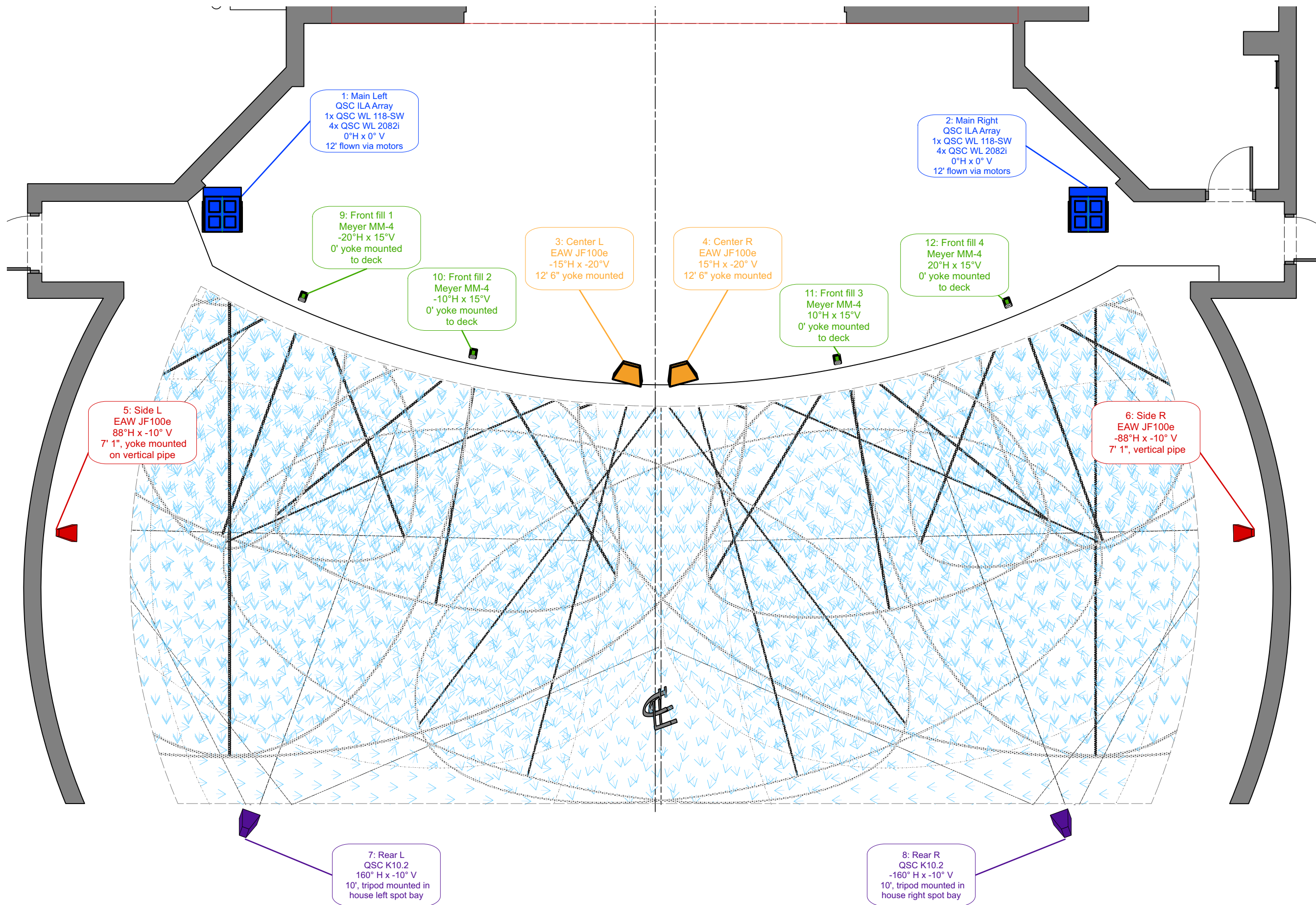

Affinity Lunch Minutes

Complete Audience coverage

DESIGNER:
Casey Deiter
casey.deiter@ucf.edu

SCALE:
3/16" = 1'-0"

DRAWN:
04/27/22

PLATE

6

OF 9

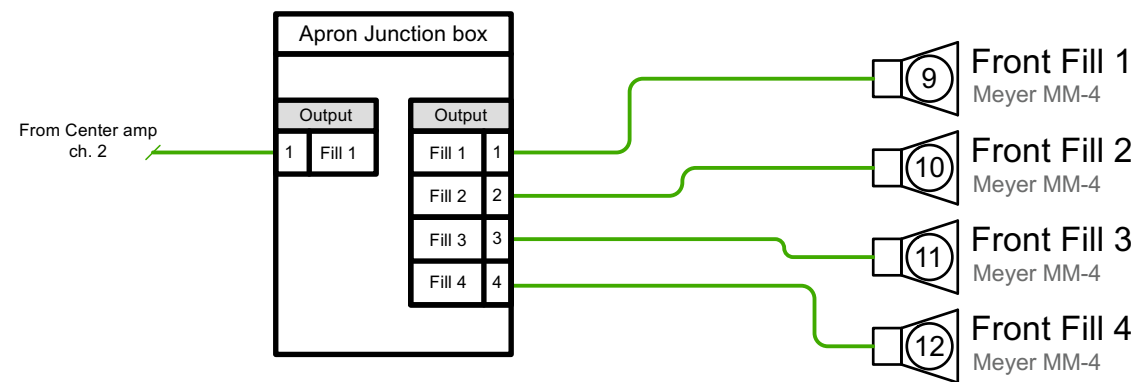
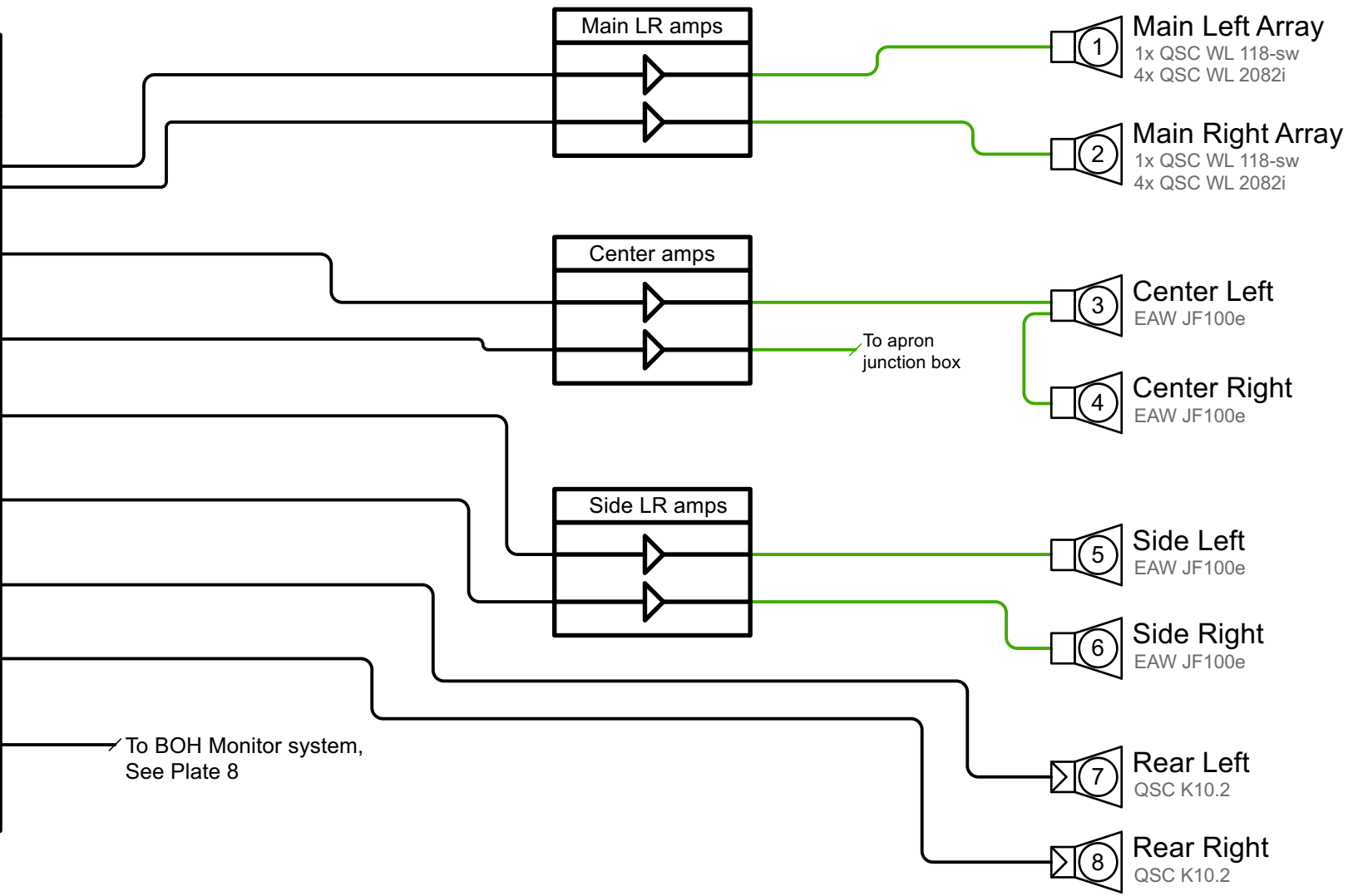
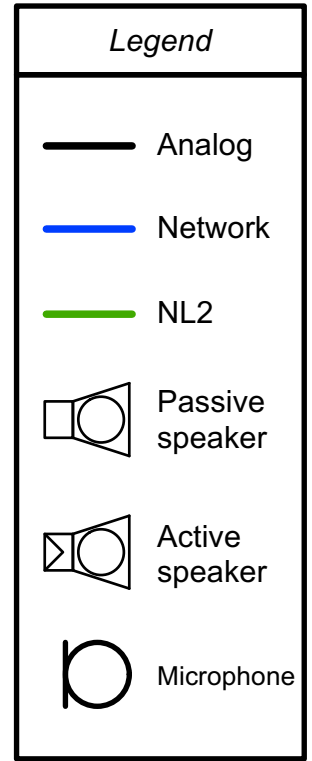
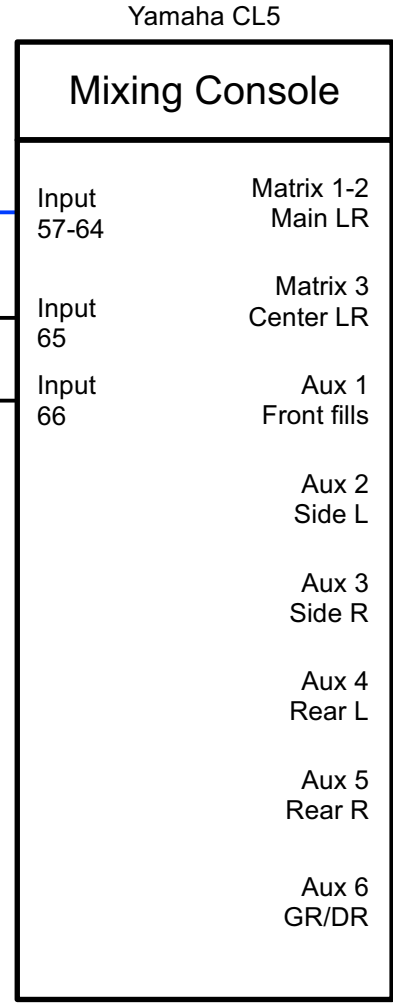
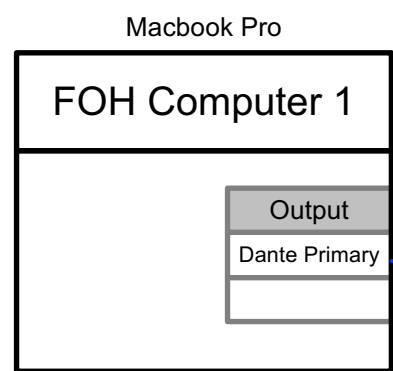

Affinity Lunch Minutes

System Block Diagram

DESIGNER:
Casey Deiter
casey.deiter@ucf.edu

SCALE:
N/A

DRAWN:
04/27/22

PLATE
7

OF 9

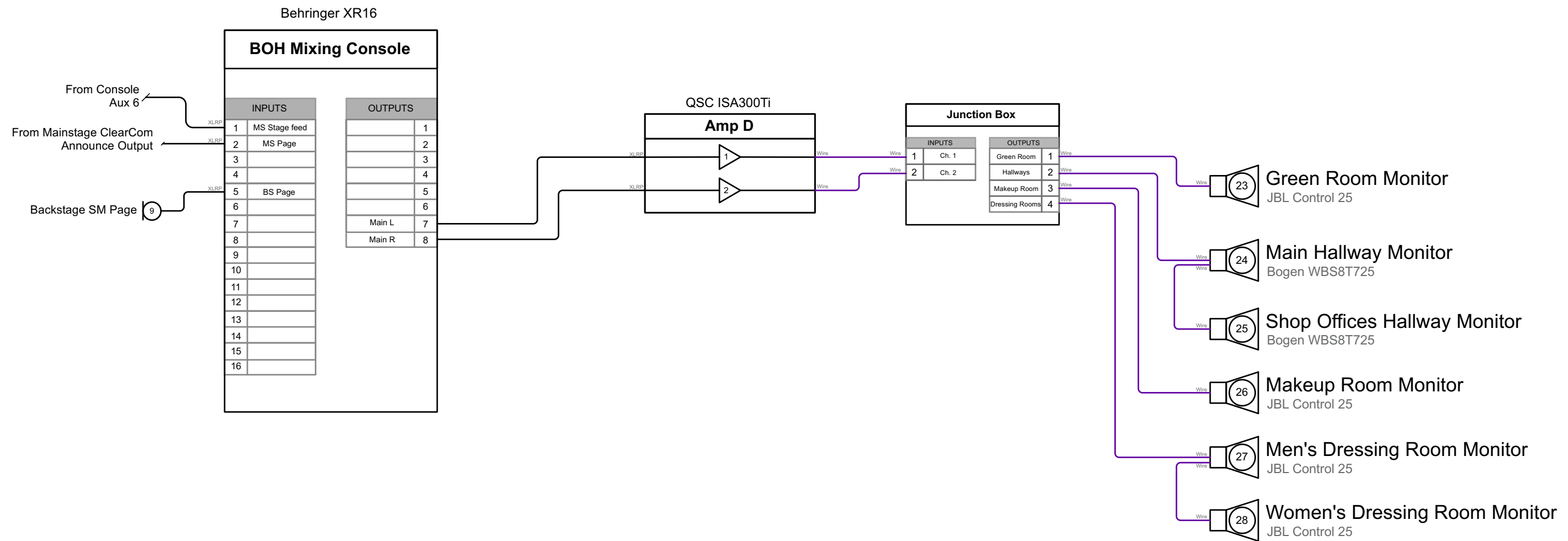

Legend

- Analog
- Network
- 12g Wire
- Passive speaker
- Active speaker
- Microphone

Affinity Lunch Minutes

BOH Monitoring

DESIGNER:
Casey Deiter
casey.deiter@ucf.edu

SCALE:
N/A

DRAWN:
04/27/22

PLATE

8

OF 9

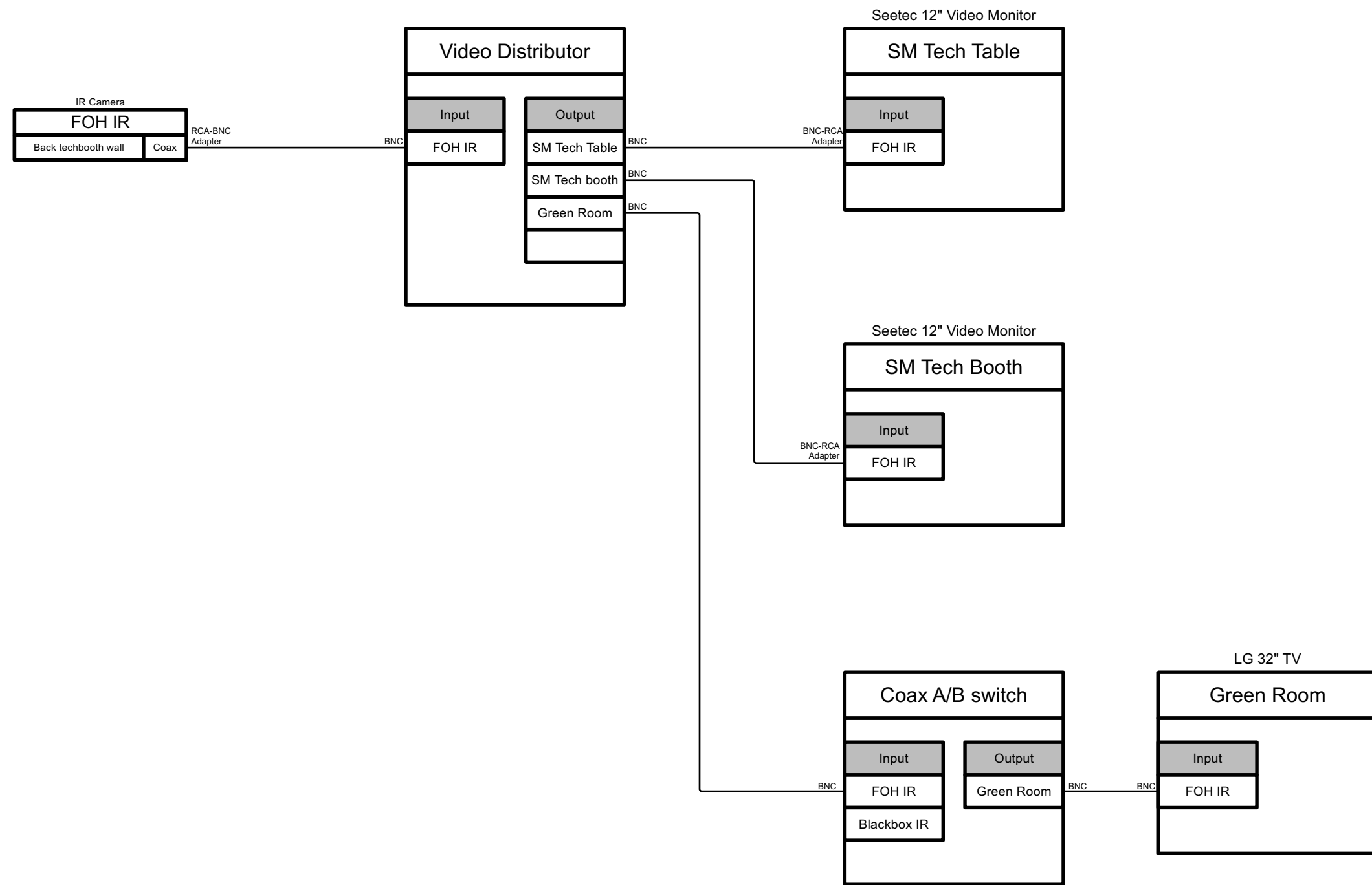

Affinity Lunch Minutes

Internal Video Monitoring

DESIGNER:
Casey Deiter
casey.deiter@ucf.edu

SCALE:
N/A

DRAWN:
04/27/22

PLATE

9

OF 9

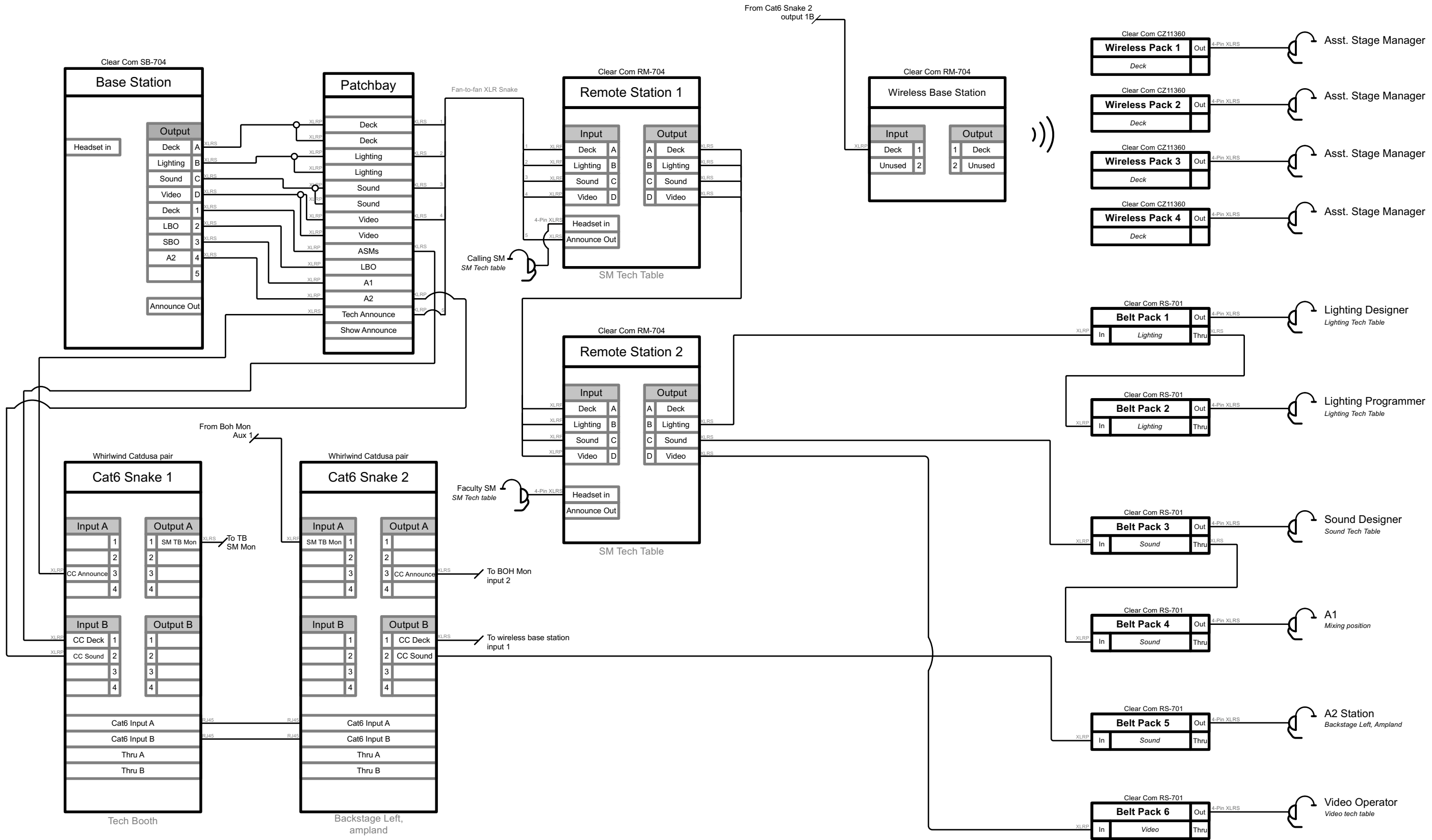

Affinity Lunch Minutes

Clear-Com Block Diagram

DESIGNER: Casey Deiter casey.deiter@ucf.edu

SCALE: N/A

DRAWN: 04/27/22

PLATE

10

OF 10